

# McIntosh

## FM STEREO TUNER

# MR67

### TABLE OF CONTENTS

INTRODUCTION	1
TECHNICAL DESCRIPTION	1
FRONT PANEL INFORMATION	4
BACK PANEL INFORMATION	6
INSTALLATION	7
CONNECTING	7
Audio Outputs	7
Stereophonic FM Multiplex	8
Monophonic FM	8
Remote Amplifiers	8
Off-The-Air Recording	8
Antenna Connections	8
OPERATING INSTRUCTIONS	10
Stereophonic FM Multiplex	10
Monophonic FM	11
GUARANTEE	11

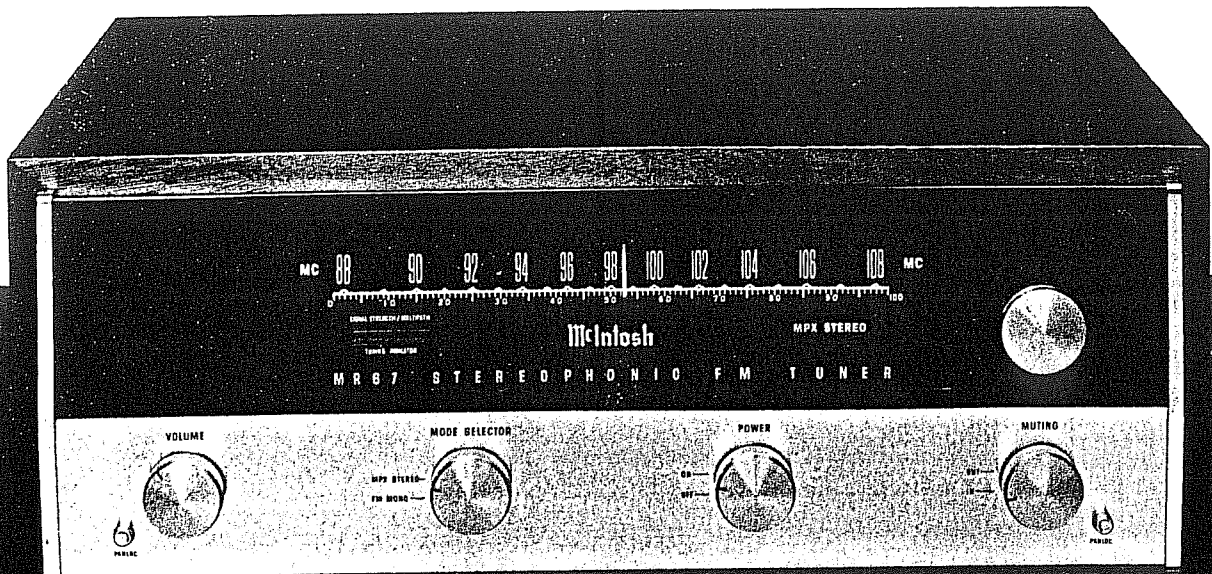

# OWNER'S MANUAL

ISSUE NO. 1

Reading Time 30 Minutes

Price \$1.25

# MR67 FM STEREO TUNER

## INTRODUCTION

The McIntosh MR67 is a precision engineered, highly sensitive FM Multiplex Tuner.

The finest possible reception of FM monophonic and FM multiplex stereophonic broadcasts is assured by another McIntosh first—a built-in MULTIPATH INDICATOR. Multipath reception of FM transmissions causes noisy and distorted sounding programs.

Multipath distortion is caused by receiving both a direct signal and one or more reflected signals. Multipath signals may be reflected from a building, water tower or even a nearby hill or mountain. The multipath reflected signals reach the antenna at slightly later times than the direct signals due to the longer distances they travel. The time differences of the direct and multipath signals at the antenna can cause moderate or severe distortion at the tuner outputs. Multipath can be eliminated or greatly reduced by proper use of a directional antenna. The MR67 multipath indicator shows when the antenna is rotated to the correct position for picking up only the desired direct signal.

The MR67 also uses the new, exclusive McIntosh PANLOC method of installation. The PANLOC system gives you absolute ease of installation, operation, and maintenance.

PANLOC is the first professional installation technique to be used on stereo instruments.

In the PANLOC system a metal shelf is mounted first, then the tuner slides into position on this shelf. Depressing the PANLOC buttons on the front panel locks the tuner firmly into place for normal operation. To unlock the tuner depress a second time the PANLOC buttons on the front panel. The tuner can now slide forward to the "ADJUST" position. The tuner will lock into this position approximately 3 inches from the mounting panel. Now you can adjust the multipath-signal strength indicator switch and the panel light switch, both of which are mounted just behind the front panel. Depressing the ADJUST position holding latches allows the tuner to be taken out of the PANLOC shelf or to slide back into position against the mounting panel.

Once you have enjoyed the outstanding performance of the MR67, you will understand why McIntosh products have earned their reputation as "THE BEST." Your McIntosh MR67 tuner will give you years of the finest possible FM reception, and will become a highly valued part of your home music system.

## TECHNICAL DESCRIPTION

The MR67 tuner has a 6DS4 high-gain Nuvistor for the first RF amplifier stage. The Nuvistor (triode) operates into a triode tube to form a cascode amplifier. Careful design of the operating characteristics allows the cascode amplifier to handle a wide dynamic range of signals with excellent signal-to-noise ratio. Proper design of circuit constants, together with extreme care in manufacturing, reduces spurious signals to a minimum. Sensitivity is increased to the highest possible degree, while still retaining high selectivity. A low-noise triode mixer follows the RF stages.

The high frequency oscillator mechanical construction and layout are engineered for

minimum responses to temperature variations. The combination of both mechanical and electronic design in the MR67 oscillator circuit is so precise that a compensating automatic frequency control is not needed.

The mixer output is amplified through four intermediate frequency stages with flat-topped highly selective response curves. The IF transformers are designed for wide band response with maximum adjacent channel rejection. Construction of the IF transformers assures electrical stability and resistance to mechanical shock and vibration.

Two limiter stages are used followed by a wide-band discriminator. The second limiter is part of the muting circuit which automat-

ically suppresses interstation noise while tuning. Weak or distant stations that don't override the background noise and interference are also suppressed by the muting circuit. A front panel switch allows muting to be cut out for listening to these weak stations. A back panel muting adjust control is factory-set to the proper threshold level.

The MR67 multiplex decoder uses a special McIntosh developed detector. One of the many advantages of this circuit is the elimination of critical adjustments necessary with commonly used multiplex matrixing methods. The L-R (left minus right) stereo sidebands are detected and then automatically combined with the L+R main carrier signal. The left and right channel signals are then produced with excellent separation.

A temperature-stabilized 19 KC amplifier locks-in a highly stable 38 KC synchronous oscillator. This method provides exceptional noise immunity. Balanced detectors cancel the 38 KC signal components in the output for lowest distortion and reduced susceptibility to spurious signals. Tape recording interference is also minimized by this method.

The MR67 has a multiplex stereo indicator that lights whenever the dial pointer crosses a station broadcasting multiplex stereo. A unique circuit using a transistor as a switch operates the MPX stereo indicator lamp. The transistor is controlled by a special noise-rejecting differential detecting bridge-circuit. This circuit automatically discriminates between noise and the 19 KC multiplex pilot signal. The indicator will light only on the 19 KC signal present in a multiplex stereo broadcast. It will not light on noise or interference.

The dual electron ray tube at the left on the tuning dial serves three separate indicator functions. The upper half of the tube is a multipath signal indicator, a unique and exclusive McIntosh development. Multipath signal reception causes moderate or severe distortion and poor stereo channel separation. By knowing the presence of multipath reception, a directional FM antenna may be properly rotated to reduce or eliminate the multipath signal and the poor sound quality it causes. The MR67 multipath indicator shows whether multipath signals are present by rapid fluctuations of the electron ray beams. When the antenna is correctly positioned, the indicator beams remain steady, showing that multipath distortion has been eliminated.

A switch behind the front panel allows this section of the electron ray tube to also function as a signal strength indicator.

The lower half of the electron ray tube indicates correct station tuning.

Two identical audio amplifier circuits are used in the MR67. Negative feedback reduces distortion and lowers the tuner output source impedance for best operation with any type of control preamplifier.

A new type of mechanical tuning assembly gives the MR67 an extremely smooth, quiet, flywheel tuning action. The tuning capacitor is driven directly, which in turn drives the dial pointer. Backlash is virtually eliminated with this design. A teflon-lined pointer carriage and nylon pulleys are used to practically eliminate friction and wear. The overall result is unusually smooth, quiet and precise tuning action.

## SPECIFICATIONS

### Useable Sensitivity

Better than 2.5 microvolts at 100% modulation (+75KC deviation) for less than 3% total noise and distortion in accordance with IHFM standards.

### Audio Frequency Response

Within 1/2 db 20 to 20,000 cycles, including 75 microsecond de-emphasis.

### IF Bandwidth

200KC flat top response, down 3 db at 200KC.

### Limiters

Two stages.

### Radiation

Substantially below FCC requirements.

**Distortion**

Less than 0.5% at 100% modulation,  $\pm 75$ KC deviation.

**Capture Ratio**

1.7 db at 100% modulation.

**Muting**

IF injected; at least 60 db quieting between stations.

**Drift**

Less than 25KC.

**Image Rejection**

Better than 60 db.

**Hum**

Better than 70 db below 100% modulation.

**Output**

Approximately 2.5 volts, low-source impedance.

**Antenna Inputs**

300 ohms balanced, 75 ohms unbalanced.

**RF Amplifier**

Cascode with 6DS4 Nuvistor in first stage.

**IF Amplifiers**

Four stages; AGC used to insure that limiting occurs only in the limiter stages.

**Tuning Indicators**

Dual electron ray tube; lower section for precise tuning indication; upper section for signal strength presentation (can be switched to indicate multipath distortion).

**FM Multipath Distortion Indicator**

An exclusive new McIntosh development; the upper section of the dual electron-ray tube can be switched to indicate multipath distortion or signal strength.

**Multiplex Channel Separation**

Better than 30 db at 1000 cycles.

**Multiplex Filter**

Greater than 40 db suppression below 100% modulation of 19KC pilot and 38KC carrier.

**Multiplex Indicator**

MPX stereo light activated by 19KC carrier.

**Multiplex Type**

Peak-detecting, self-matrixing circuit.

**Tube and Semiconductor Complement**

1—6DS4 Nuvistor 1st RF amplifier.

1—12AT7 2nd RF amplifier and mixer.

1—6AB4 Oscillator.

1—6AU6 1st IF.

1—6AU6 2nd IF.

1—6AU6 3rd IF; 1st limiter.

1—6CS6 4th IF; 2nd limiter.

1—6AV6 Muting amplifier; AGC clamp.

1—EMM801 Tuning indicator, signal strength indicator, Multipath distortion indicator.

1—6U8 MPX amplifier and 19KC separator-Indicator control.

1—12AU7 MPX 38KC oscillator.

2—6BL8 left and right audio amplifiers.

1—MA113 Transistor. (multiplex indicator lamp switch).

2—1N542 Diodes, wide band discriminator.

4—1N542 Diodes, balanced MPX detector.

2—1N542 Diodes, balanced detector for MPX indicator.

1—1N541 Diode, muting and tuning indicator detector.

2—Selenium rectifiers, high-voltage supply.

1—1850 pilot lamp, MPX indicator.

**Power Consumption**

50 watts, 105 to 125 volts, 50 to 60 cycles.

**Dimensions**

Front panel; 16 inches wide by  $5\frac{7}{16}$  inches high; chassis (including PANLOC shelf) 15 inches wide by  $5\frac{1}{8}$  inches high by 13 inches deep, including connectors; clearance in front of mounting panel including knobs,  $1\frac{1}{2}$  inches.

**Weight**

Tuner only,  $24\frac{1}{2}$  pounds.

In shipping carton, 33 pounds.

**Finish**

Anodized gold and black front panel; chrome chassis.

**Installation**

Convenient professional PANLOC, (see PAN-LOC Installation folder.)

## FRONT PANEL INFORMATION

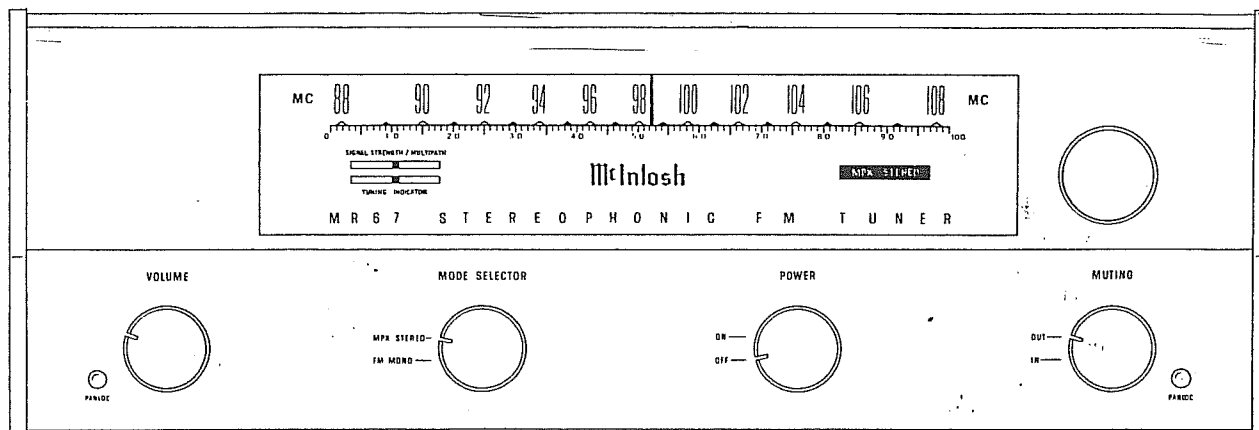

Figure 1. MR67 Front Panel.

### TUNING DIAL SCALES

The MR67 has two dial scales. The 88 to 108 scale is marked in megacycles. The 0 to 100 scale is the logging scale. The logging scale can be used to accurately retune any station. You may find it easier to keep a record of your favorite stations by use of the logging scale.

### INDICATORS

**MPX STEREO**

Figure 2. MPX Stereo Indicator.

The MR67 has three indicators on the dial panel, one of which performs two functions. At the right is the multiplex stereo indicator light. At the left is a dual electron ray indicator.

SIGNAL STRENGTH / MULTIPATH  
  
 TUNING INDICATOR

Figure 3. Signal Strength—Tuning—Multipath Indicator.

Both sections of the electron-ray indicator operate by movement of electron beams inside a vacuum tube.

The upper section of the indicator shows distortion resulting from multipath signal reflection, when the Indicator Function switch (behind the front panel) is set to MULTIPATH POSITION. The MR67 Multipath distortion indicator is a new and exclusive McIntosh development. The multipath indicator shows when the antenna is rotated to the correct position for picking up only the desired signal. Multipath distortion causes the two beams on the indicator to fluctuate rapidly with the incoming signal. When the antenna is rotated to the correct position, the indicator beams will remain steady. The directional antenna is then picking up only the desired signal and rejecting the reflected multipath signals. In certain locations it is possible for best reception to occur by picking up a strong reflected signal rather than the direct signal. Whenever you tune to a different station, the multipath indicator will tell you if multipath distortion is present. Multipath distortion is practically independent of signal strength.

The upper section of the indicator shows station signal strength when the Indicator Function switch is set to SIGNAL STRENGTH POSITION. The beams move together when a station is precisely tuned. Strong local stations will cause the beams to come very close together or even touch. Weaker stations will cause the beams to close a smaller amount. Only the very weakest signals will not affect the signal strength indicator.

The lower section of the indicator shows correct station tuning. The two electron beams move closer together as the station comes into tune. The station is precisely tuned when the beams come closest together. The action of this indicator is substantially independent of the station signal strength. Only the very weakest signals will not close the beams to the on-tune position.

The MPX STEREO indicator will light whenever the dial pointer crosses a station broadcasting multiplex stereo. The special circuit used causes the indicator to light ONLY on the 19KC multiplex carrier present in a multiplex stereo broadcast. The indicator will not light on noise pulses or interference.

### VOLUME

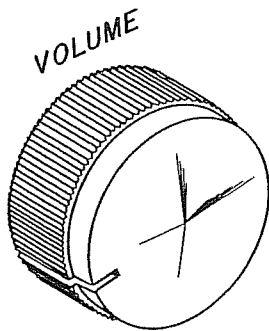

Figure 4. VOLUME Control.

This control adjusts the output volume level of the tuner at the back panel Audio Output jacks marked "Through volume control." The other pair of Audio Output jacks is marked "Fixed Output," and is not affected by the volume control. Full tuner output is always present at the Fixed Output jacks.

### MODE SELECTOR

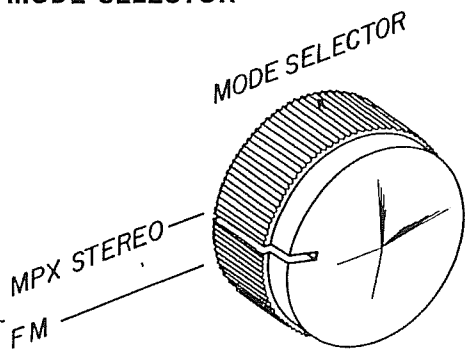

Figure 5. MODE SELECTOR.

### MPX Stereo

This position provides FM multiplex stereo at the respective left and right channel Audio Output jacks.

### FM Mono

This position provides monophonic FM at both pairs of left and right channel Audio Output jacks.

### POWER

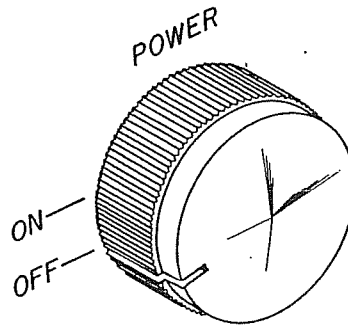

Figure 6. POWER ON-OFF.

This control turns off the tuner AC power, and also turns off the extra AC outlet on the tuner back panel.

### MUTING

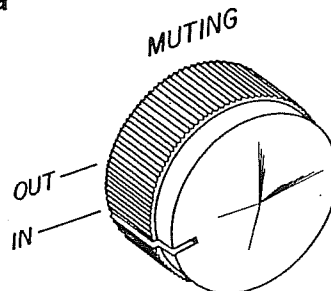

Figure 7. MUTING Control.

### In

This position turns on the muting circuit. Muting suppresses all background hiss and noise usually heard when tuning between stations. Weak or distant stations that may not override the background noise and interference are also suppressed by the muting.

### Out

This position turns off the muting to allow conventional tuning with inter-station noise present. Use this setting to listen to weak or distant stations that may be mixed with noise or interference.

## PANLOC BUTTONS

At the bottom front corners are the PANLOC buttons. After a tuner is installed on the PANLOC shelf, depressing the PANLOC buttons will lock the tuner firmly in position. Depressing the PANLOC buttons a second time (as with a ball-point pen) will

release the tuner. The tuner can then be slid forward to the inspection and adjustment position. The PANLOC system gives you absolute ease of installation, operation and maintenance.

## BACK PANEL INFORMATION

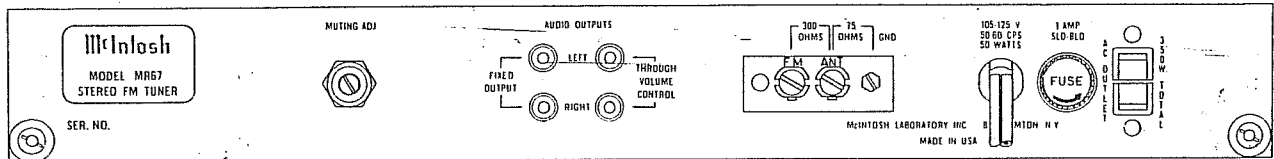

Figure 8. MR67 Back Panel.

### MUTING ADJ



Figure 9. MUTING ADJ Control.

This control adjusts the operating threshold of the muting circuit. The MR67 muting circuit suppresses all noise between stations. It also suppresses all weaker stations not strong enough to override the noise.

The muting threshold setting determines the strength of the signal which can be heard with muting in operation. The muting threshold is carefully adjusted to optimum at the factory using precision test instruments. Casual adjustment of the muting threshold is not recommended.

If it is found necessary to adjust the muting threshold, use the MUTING ADJ on the MR67 back panel. Turn the MUTING ADJ to the RIGHT (clockwise) to lower the muting threshold. This allows weaker noisier stations to be heard at the MUTING IN setting. Turn the MUTING ADJ control to the left (counterclockwise) to raise the muting threshold. This allows only the more powerful stations to be heard at the MUTING IN setting.

### AUDIO OUTPUTS—LEFT RIGHT

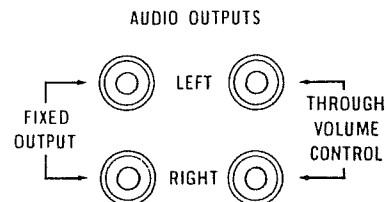

Figure 10. MX110 AUDIO.

The pair of audio output jacks marked FIXED OUTPUT provides FM signals at full output which are not affected by the MR67 volume control. Use these jacks to connect the tuner to a stereo control preamplifier which has level adjust controls or a master any equipment which requires continuous front panel control of tuner volume. You may use either pair of outputs with McIntosh preamplifiers.

### 1 AMP SLO BLO

A 1 ampere slo-blo fuse protects the tuner circuits. This fuse does not protect additional equipment connected to the back panel AC outlet.

### AC OUTLET

Provides 117 volt AC power up to 350 watts maximum. The outlet is not fused and turns on and off with the front panel power switch.

### 300 OHM—75 OHM ANTENNA

Terminals for connecting an FM antenna to the MR67.

### CONTROLS BEHIND THE FRONT PANEL

Depressing the PANLOC buttons allows the MR67 to slide forward from the mounting panel. In this position, two additional controls on top of the MR67 chassis are available, the Indicator FUNCTION control and the PILOT LAMP INTENSITY.

### INDICATOR FUNCTION CONTROL

The indicator Function control switches the top section of the electron ray indicator on the front panel either to show SIGNAL STRENGTH, or to show MULTIPATH distortion.

### PILOT LAMP INTENSITY

The control marked PILOT switches the front panel pilot lamps to DIM or BRIGHT. The DIM setting extends lamp life.

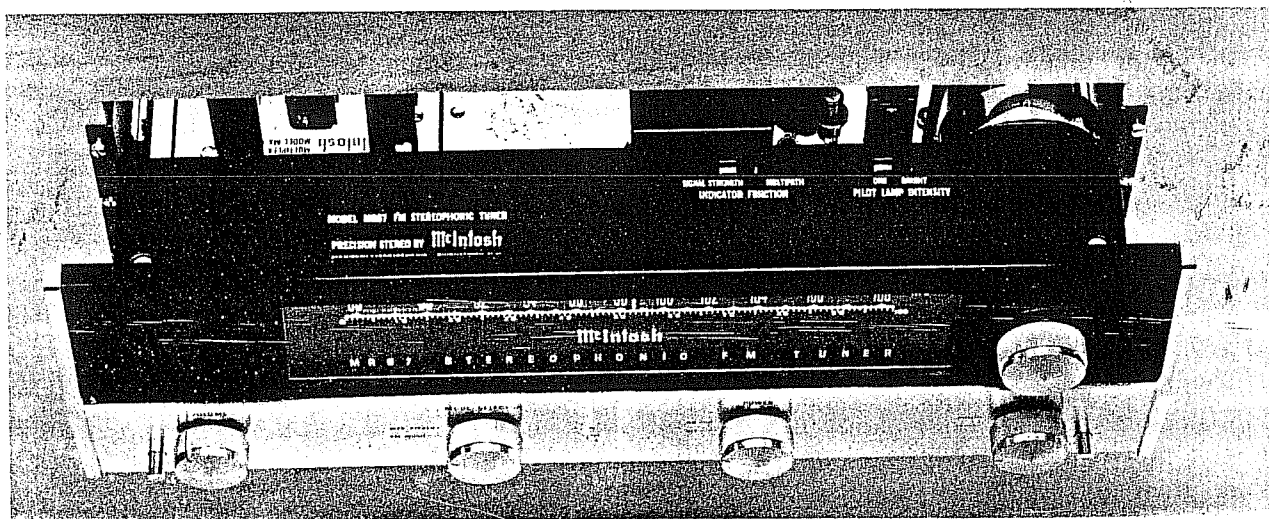

Figure 11. INDICATOR Control and PILOT LAMP INTENSITY.

## INSTALLATION

The McIntosh MR67 tuner may be installed on a table, on a shelf, in a custom built-in cabinet, or in a professional equipment rack. For best appearance in an open installation, mount the MR67 in the attractive McIntosh L10W or L10WO cabinet. The L10W is finished in walnut veneer. The L10WO is natural oiled walnut.

The MR67 tuner is installed by the new exclusive McIntosh PANLOC method. Refer to the special PANLOC SYSTEM INSTALLATION instructions included with your MR67.

The MR67 cabinet installation needs at least  $13\frac{3}{4}$  inches behind the mounting panel for clearance of leads and connectors. Allow inside dimensions of at least  $16\frac{1}{2}$  inches in width and 6 inches in height for adequate air circulation. The back panel of the MR67 cabinet should be left as open as possible for best ventilation. Avoid mounting the tuner directly over a power amplifier. The heat from the amplifier may affect the precision tuner calibration. Adequate ventilation will insure your tuner a long and trouble-free life.

## CONNECTING

### AUDIO OUTPUTS

Use the FIXED OUTPUT jacks to connect to a conventional control preamplifier which has its own volume control. Full tuner output is available at all times from the FIXED OUTPUT jacks.

Use the THROUGH VOLUME CONTROL jacks to connect to a conventional control preamplifier when continuous front panel control of tuner volume is desired. These jacks may also be used to connect to external equipment such as power amplifiers or tape



recorders where control of tuner volume is necessary. There is no difference in the signal quality or available output levels at each pair of output jacks.

### STEREOPHONIC FM MULTIPLEX

Connect a shielded cable from the tuner LEFT channel AUDIO OUTPUT jack to the control preamplifier LEFT channel tuner or auxiliary input jack.

Connect a second shielded cable from the RIGHT channel tuner AUDIO output jack to the corresponding control preamplifier RIGHT channel tuner or auxiliary input jack. When the MR67 is set to FM MONO, monophonic signals will automatically be present at both left and right outputs.

Suitable shielded cables are supplied with the tuner.

### MONOPHONIC FM

The MR67 may be used strictly for monophonic reception if desired.

Connect a shielded cable from either the left OR right audio output jack to the monophonic control preamplifier auxiliary or tuner input jack. With the MR67 MODE SELECTOR set to FM MONO, the monophonic FM signal appears at both the left and right channel AUDIO OUTPUT jacks.

### REMOTE AMPLIFIERS

The pair of audio output jacks not being used in an installation may be connected to external or remote amplifiers. FM programs may then be fed to speaker systems apart from the main sound system.

### OFF-THE-AIR RECORDING

Tape recorders or tape decks with record-playback preamplifiers are normally connected to the Tape Output jacks on the control preamplifier. Any FM program coming through the tuner into the preamplifier can then be recorded on tape. You may also connect the extra pair of tuner audio output jacks directly to the recorder inputs if desired.

### ANTENNA CONNECTIONS

Satisfactory FM multiplex stereo reception requires approximately 10 times as much

signal from the antenna compared to equivalent FM monophonic reception. Monophonic installations that were satisfactory with an indoor FM antenna may require an outside or directional FM antenna for equivalent multiplex stereo reception. A good directional antenna with a rotator also makes it possible to eliminate or minimize multipath distortion. The MR67 multipath indicator quickly shows the correct antenna position for reception without multipath distortion.

### INDOOR FLEXIBLE FM DIPOLE

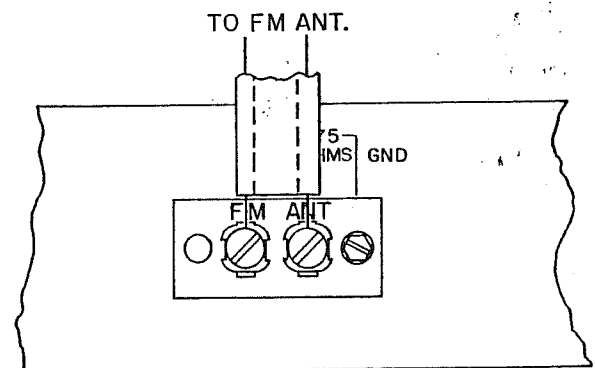

Figure 12. Connection of 300 Ohm Indoor Dipole FM Antenna

A convenient flexible indoor FM dipole (300 ohm) antenna is supplied with the MR67 tuner. This antenna is easy to install and is suitable for good FM reception in urban or high intensity signal areas.

Connect the two leads of the dipole antenna to the two terminals marked 300 OHM on the MR67 back panel.

The flexibility of the thin flat wire allows the dipole to be easily located behind the equipment enclosure or in any position near the tuner. Open the dipole into a "T" and extend the arms as straight as possible. The dipole antenna is somewhat directional and may have to be positioned in a particular location for best reception of desired stations.

Experimenting with the dipole position may also be necessary to reduce multipath distortion on certain stations. Since it is not convenient to continually change position of

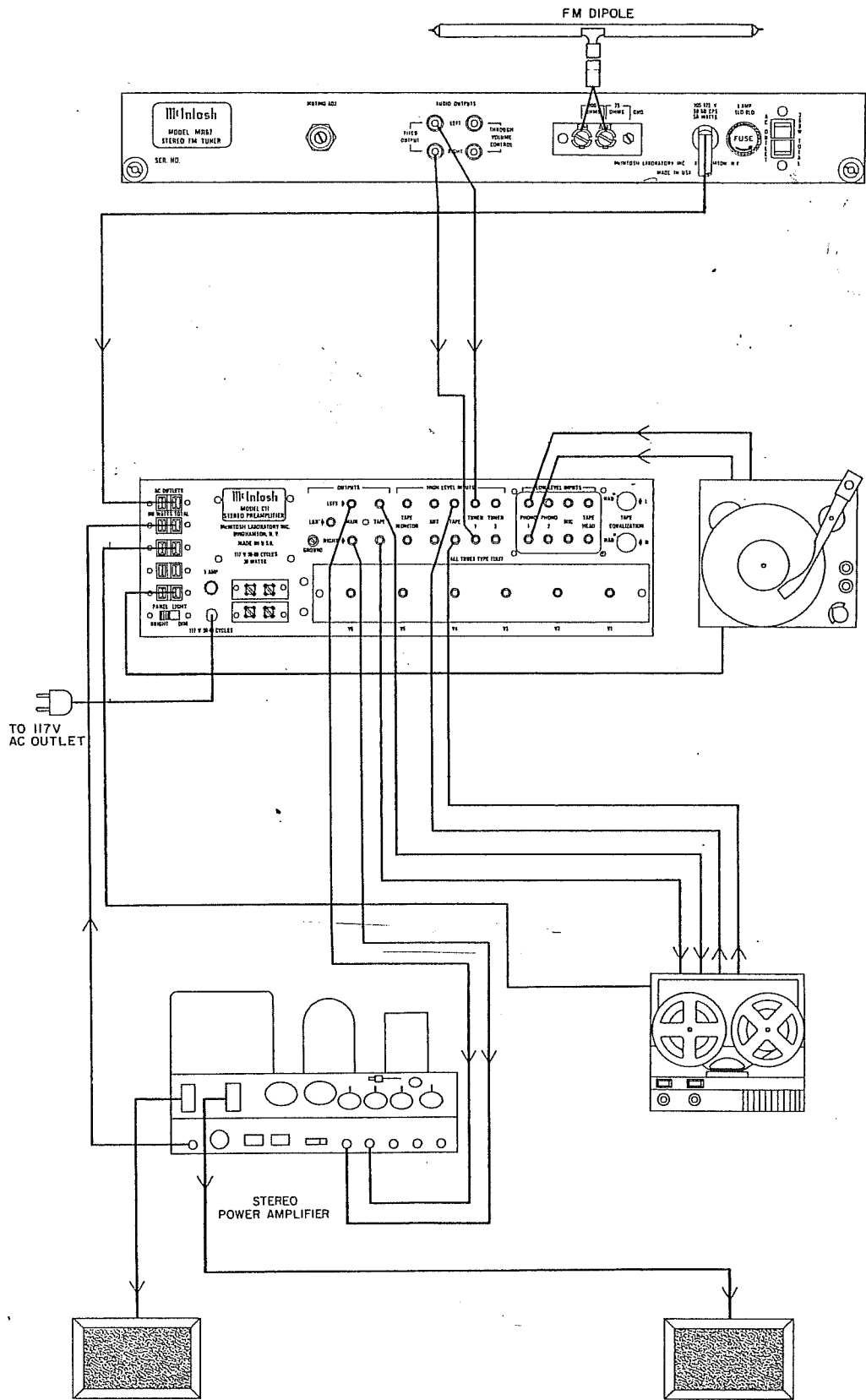

Figure 13. MR67 Typical Hook-up.

the flexible dipole, it may have to be set for minimum multipath on your favorite station.

### IMPORTANT

Keep the dipole away from large metal objects or surfaces since they may interfere with the efficiency of the antenna.

## OUTDOOR FM ANTENNA

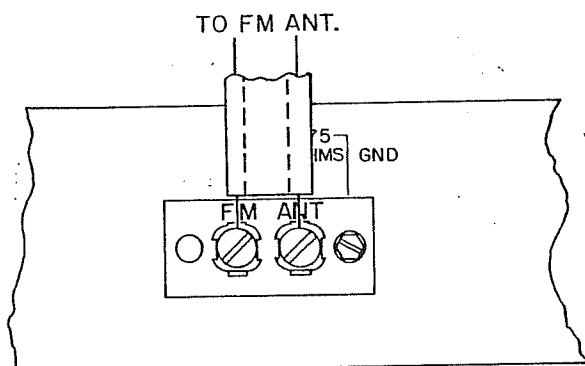

Figure 14. Connection For 300 Ohm Outdoor FM Antenna.

An outdoor FM antenna is always recommended for best FM reception under all conditions. In fringe or outlying areas especially, a highly directional FM antenna used in conjunction with a rotator will give the finest possible FM reception. Rotate the antenna

until it points in the direction of the station, or until it receives the best possible signal. Use the multipath, signal strength and tuning indicators to tell when the antenna is correctly positioned.

## 75 OHM ANTENNA

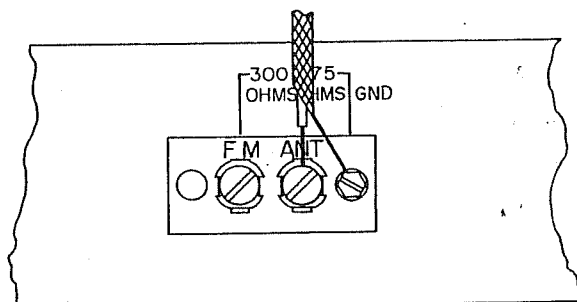

Figure 15. Connection For 75 Ohm Coaxial Antenna.

An unbalanced 75 ohm FM antenna may also be used with the MR67. Connect the center lead of the coaxial lead-in cable to the 75 ohm terminal. Connect the outer shield of the coaxial to the ground screw next to the 75 ohm terminal.

## OPERATING INSTRUCTIONS

### STEREOPHONIC FM MULTIPLEX

1. Turn the MODE SELECTOR to MPX STEREO.

2. Turn MUTING to IN

Muting suppresses all background noise and hiss usually heard when tuning between stations. Use MUTING IN for all normal listening.

Weak or distant stations that don't override the background noise are also suppressed. Turn MUTING OUT to listen to these weaker stations.

3. Turn the FM TUNING dial to the desired station.

The electron ray tuning indicator beams should come as close together as possible for precise tuning. If the red MPX STEREO indicator lights, the station is broadcasting a

19KC carrier for multiplex stereo. The MPX STEREO indicator lights ONLY when the tuner is receiving a station broadcasting a 19KC carrier for multiplex stereo. The indicator will not light on noise pulses or interference. If the same station is broadcasting a regular monophonic FM program, without the 19KC carrier, the MPX STEREO indicator will remain off.

4. Adjust the volume control for desired listening level.

If the fixed audio output jacks are being used, the tuner volume control will not affect the volume.

If the fixed audio output jacks are being used, the tuner volume control will not affect the volume.

## MONOPHONIC FM

1. Turn the MODE SELECTOR to FM MONO.

2. Turn MUTING to IN.

3. Turn the FM TUNING dial to the desired station. The electron ray tuning indicator beams should move close together for

precise tuning.

4. Rotate the directional antenna for best reception as shown by the signal strength and multipath indicators.

5. Adjust the VOLUME control for desired listening level.

Your MR67 will give you many years of pleasant and satisfactory performance. If you have any questions concerning the operation or maintenance of this tuner please contact:

CUSTOMER SERVICE  
McINTOSH LABORATORY INC.  
2 CHAMBERS STREET  
BINGHAMTON, NEW YORK

Our telephone number is 723-5491.  
The direct dial area code is 607.

## GUARANTEE

McIntosh Laboratory, Inc. guarantees this equipment to perform as advertised. We also guarantee the mechanical and electrical workmanship and components of this equipment to be free of defects for a period of 90 days from date of purchase. This guarantee does not extend to components damaged by improper use nor does it extend to damage incurred during transportation to and from McIntosh Laboratory, Inc.

## 3-YEAR FACTORY SERVICE CONTRACT

An application for a FREE 3-YEAR FACTORY SERVICE CONTRACT is included in the pocket in the back cover of this manual. The FREE 3-YEAR FACTORY SERVICE CONTRACT will be issued by McIntosh Laboratory upon receipt of the completely filled out application form. The term of this contract is defined in the 3-Year Factory Service Contract. If the application is not mailed to McIntosh Laboratory, only the services offered under the standard 90-day guarantee will apply on this equipment. TAKE ADVANTAGE OF 3 YEARS OF FREE FACTORY SERVICE BY FILLING IN THE APPLICATION NOW.

In Canada: Manufactured under license by:  
McCurdy Radio Industries, Ltd.  
22 Front Street West  
Toronto, Canada



# **McIntosh** LABORATORY, INC.

2 CHAMBERS STREET, BINGHAMTON, N. Y.

Made in U.S.A.

Phone—Area Code 607-723-5491